

Color I: trichromatic theory

CS 178, Spring 2011



Marc Levoy
Computer Science Department
Stanford University

Outline

- ◆ spectral power distributions
- ◆ color response in animals and humans
- ◆ 3D colorspace of the human visual system
 - and color filter arrays in cameras
- ◆ reproducing colors using three primaries
- ◆ additive versus subtractive color mixing
- ◆ cylindrical color systems used by artists (and Photoshop)
- ◆ chromaticity diagrams
 - color temperature and white balancing
 - standardized color spaces and gamut mapping

Newton's Experimentum Crucis



Isaac Newton
(1643-1727)

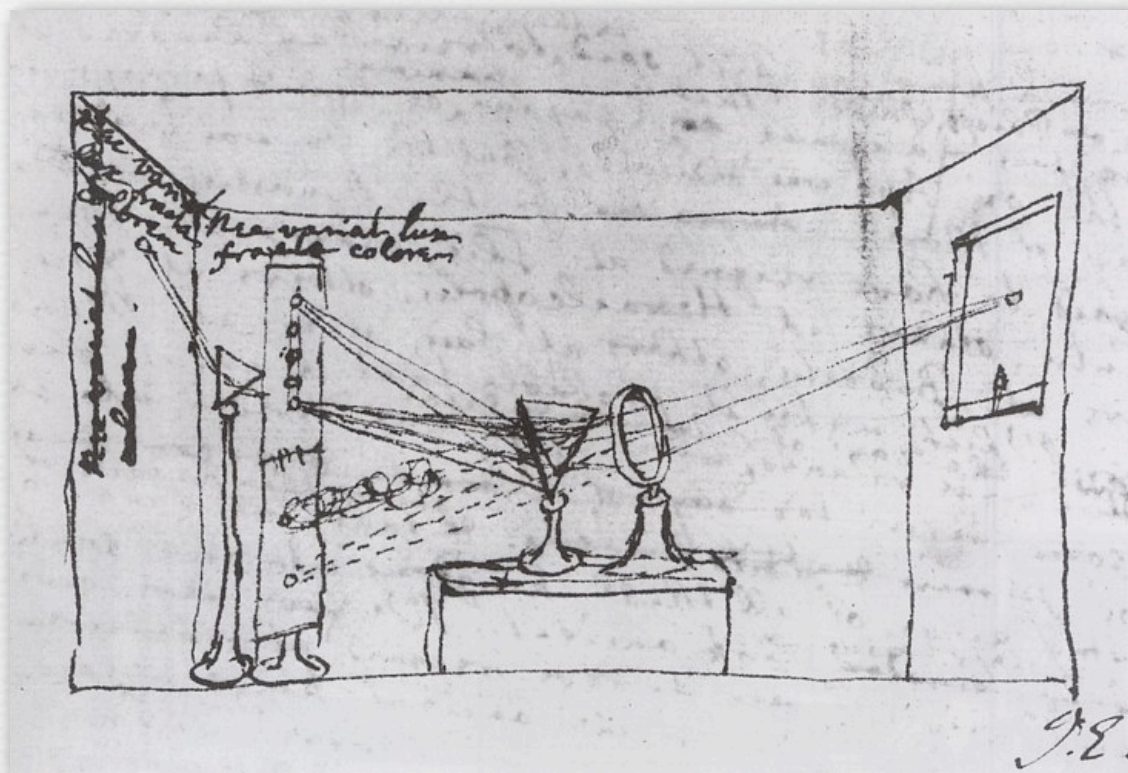

(Robin)

- ◆ sunlight can be divided into colors using a prism
- ◆ these colors cannot be further divided using a 2nd prism
- ◆ experiment performed 1665, drawing made in 1672

Newton's Experimentum Crucis

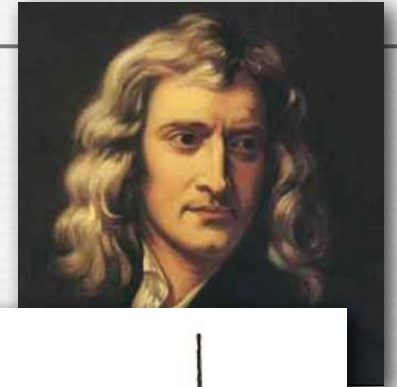

(Robin)

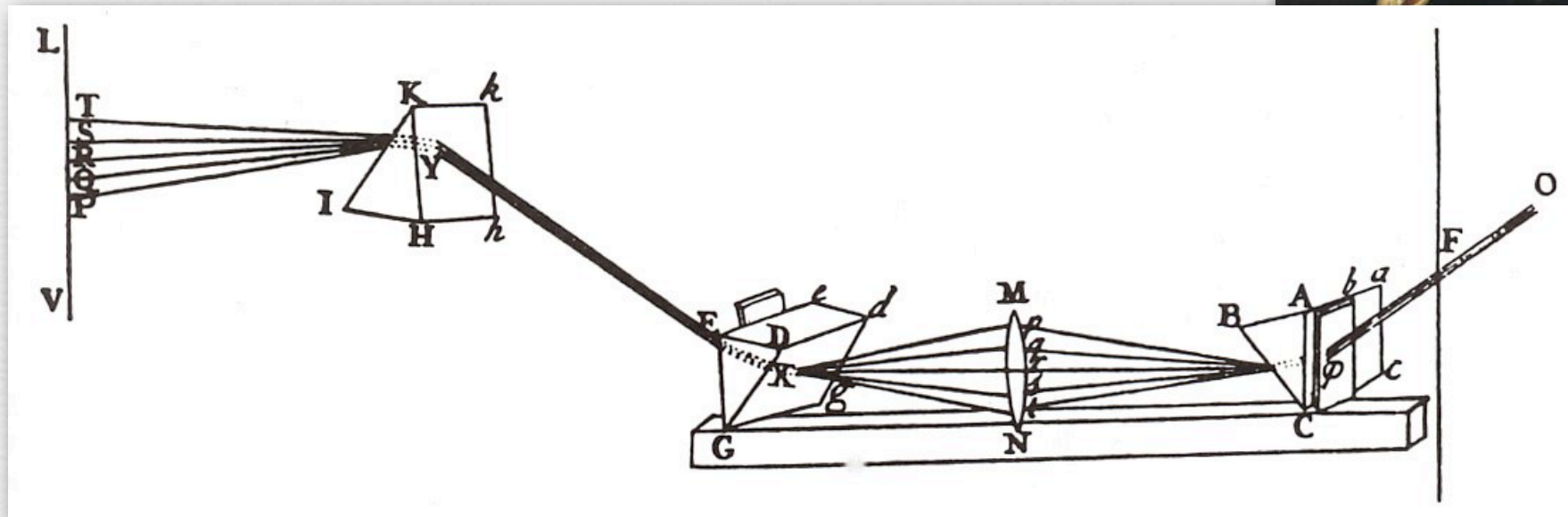

- ◆ alternatively, the divided colors can be recombined using a lens and 2nd prism into a new beam that has exactly the same properties as the original

The visible light spectrum

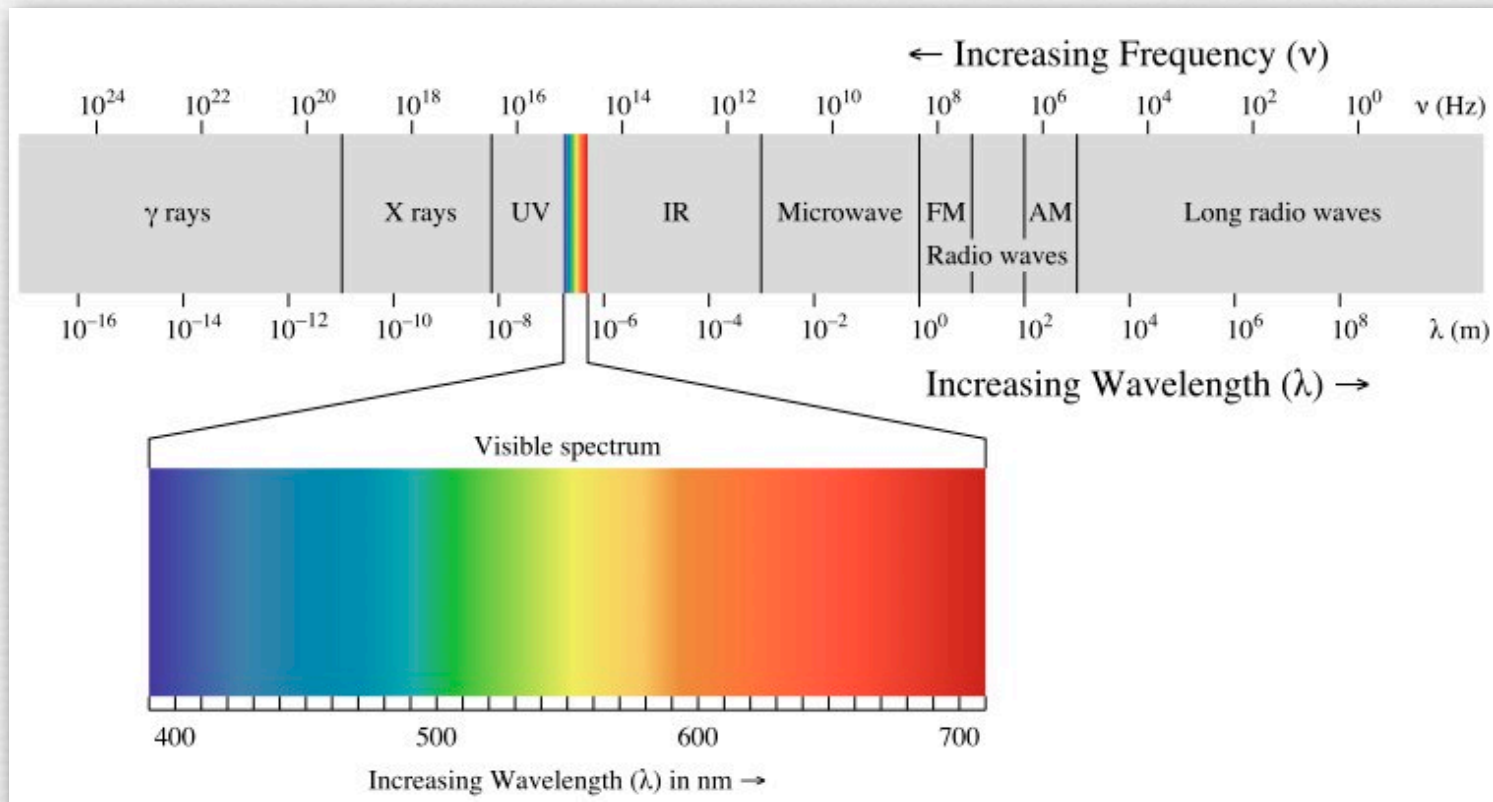

(wikipedia)

- ◆ wavelengths between 400nm and 700 nm (0.4μ - 0.7μ)
- ◆ exactly the colors in a rainbow

The visible light spectrum



(Dan Bush)

- ◆ wavelengths between 400nm and 700 nm (0.4μ - 0.7μ)
- ◆ exactly the colors in a rainbow

The visible light spectrum



- ◆ wavelengths between 400nm and 700 nm ($0.4\mu - 0.7\mu$)
- ◆ exactly the colors in a rainbow

Spectral power distribution (SPD)

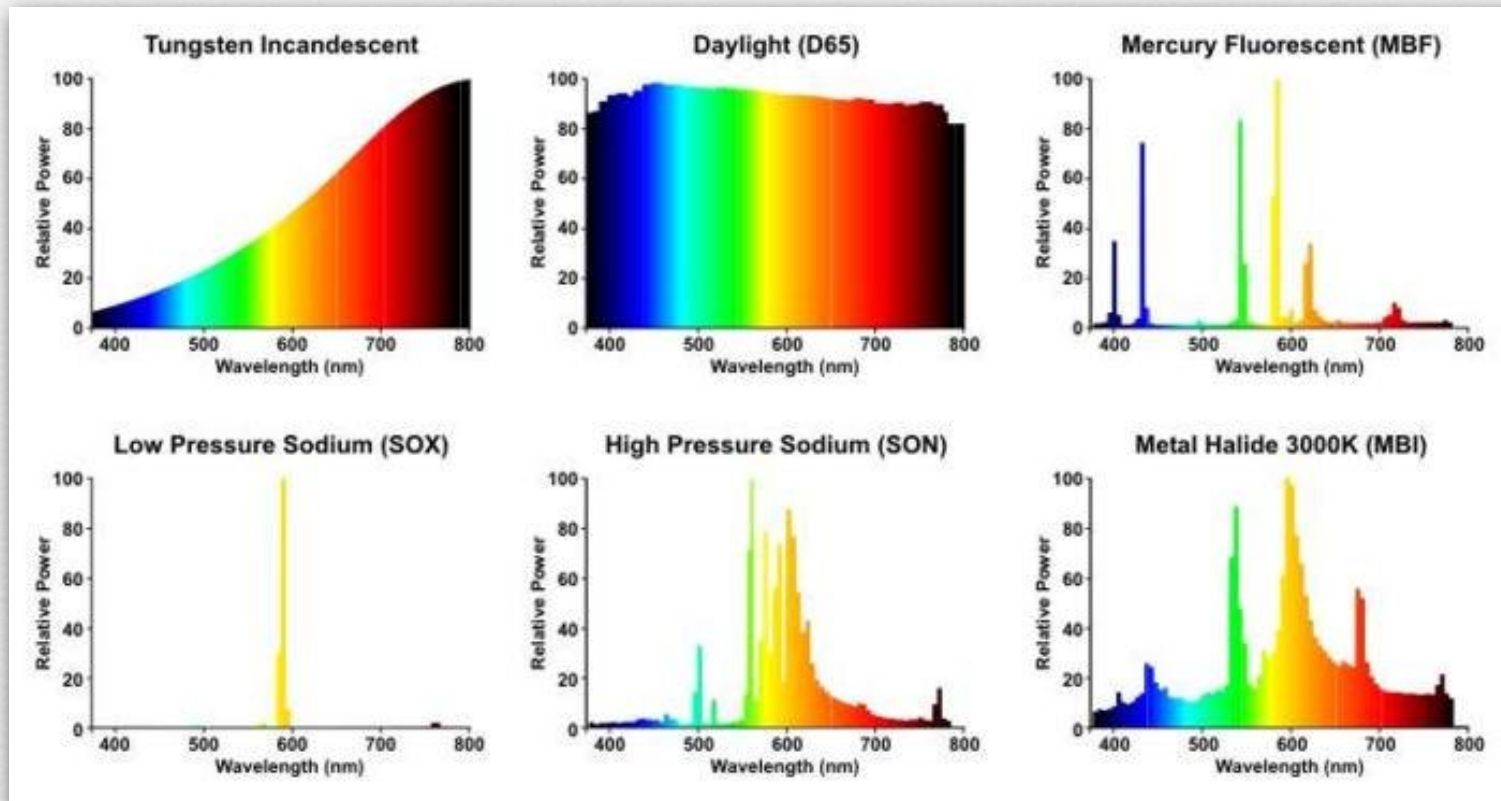

(LampTech)

- ◆ units of power are watts (joules per second)
- ◆ shown here are spectra of common illumination sources
- ◆ plots above are relative amounts (%) of each wavelength

Interaction of light with matter

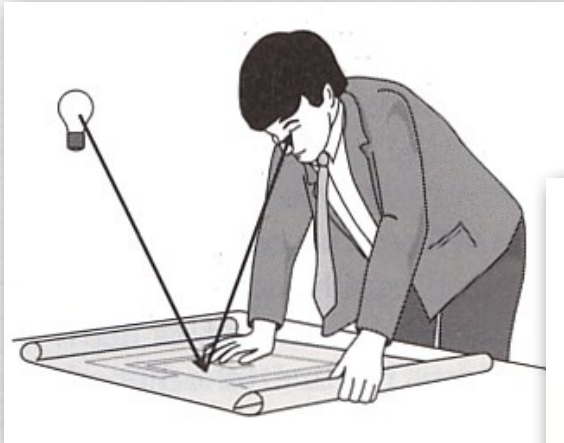

light is reflected
by an object

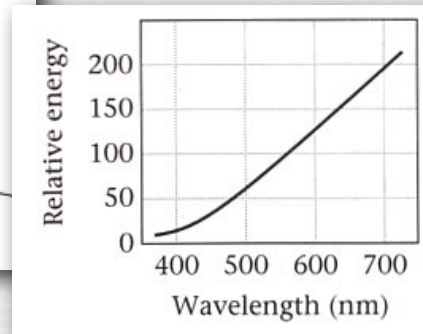

illumination

×

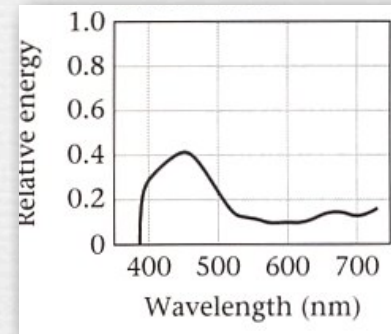

reflectance

=

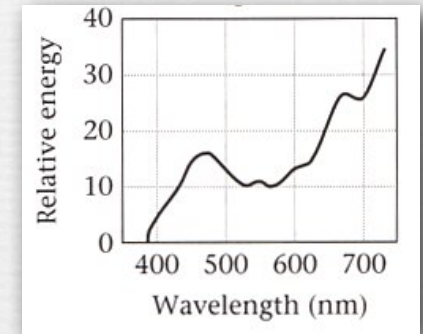

stimulus that
enters your eye

- ◆ spectrum of illumination is multiplied wavelength-by-wavelength by reflectance spectrum of object
 - cause is absorption by the material
 - so the spectrum you see depends on the illumination
- ◆ transmittance operates the same way

Examples of reflectance spectra

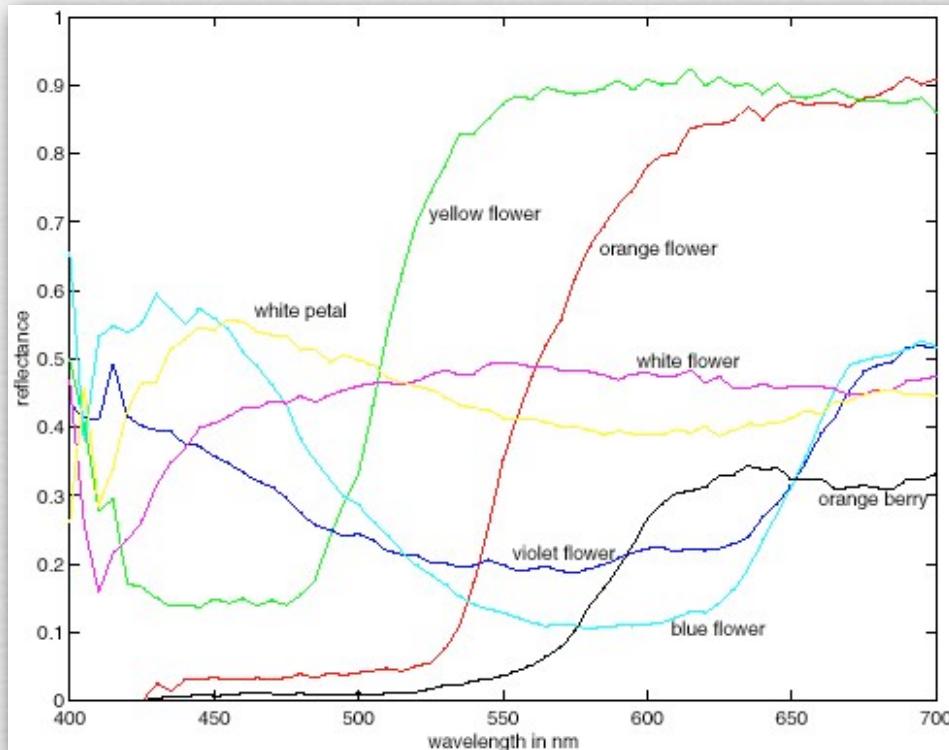

- two reflectance spectra that match (i.e. are metamers) under one illuminant may not match under another
- clothes that match in the store may not match outdoors

Questions?

- ◆ two different spectra may appear alike to us
 - white petal and white flower (above left)
 - these are called *metamers*
- ◆ Newton observed this, but could not explain it

Outline

- ◆ spectral power distributions
- ◆ color response in animals and humans
- ◆ 3D colorspace of the human visual system
 - and color filter arrays in cameras
- ◆ reproducing colors using three primaries
- ◆ additive versus subtractive color mixing
- ◆ cylindrical color systems used by artists (and Photoshop)
- ◆ chromaticity diagrams
 - color temperature and white balancing
 - standardized color spaces and gamut mapping

Monochromats (contents of whiteboard)

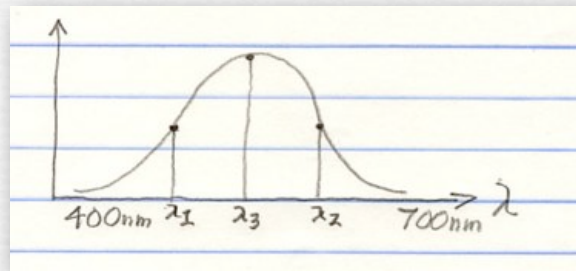

1

1. organisms having only one kind of retinal receptor cannot distinguish changes in intensity from changes in wavelength, hence they have no *color discrimination*
 - for example a unit amount of λ_1 versus λ_2 above
 - or a unit amount of λ_1 versus half as much of λ_3 (assuming the sensitivity to λ_3 is twice the response to λ_1)
 - example: horseshoe crab

Dichromats (contents of whiteboard)

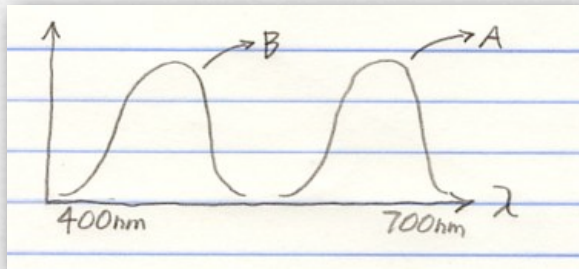

2

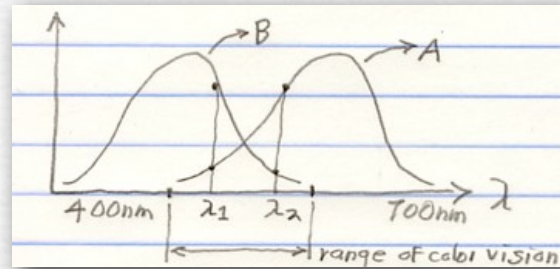

3

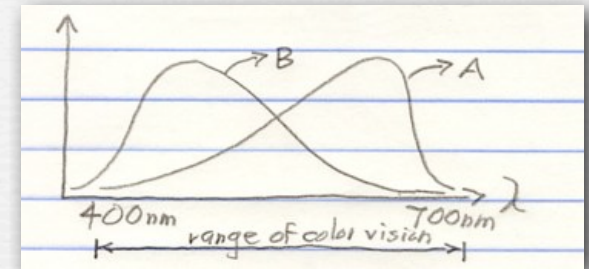

4

2. this organism can discriminate a response in the range wavelengths covered by A versus B, but cannot discriminate with those ranges
3. this organism has color discrimination over the range of wavelengths shown
 - for each wavelength within this range, the ratio of responses of receptors A and B is unique; hence the organism can identify which wavelength (e.g. λ_1 or λ_2) it's looking at
4. this organism has a larger range of color vision
 - example: dog, horse

Trichromats (contents of whiteboard)

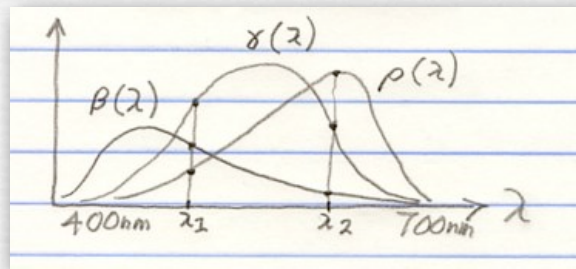

5

5. humans can discriminate wavelengths from 400nm to 700nm
 - we can also discriminate mixtures of wavelengths that dichromats cannot; this will become clearer later
 - ♦ at the retinal level, our response to light is linear
 - a. if the response to a unit stimulus at λ_1 is $(\rho_1, \gamma_1, \beta_1)$, and to a unit stimulus at λ_2 is $(\rho_2, \gamma_2, \beta_2)$, then the response to a superposition of stimuli λ_1 and λ_2 is $(\rho_1 + \rho_2, \gamma_1 + \gamma_2, \beta_1 + \beta_2)$
 - b. the response to n units of a stimulus at λ_1 is $(n \rho_1, n \gamma_1, n \beta_1)$
 - c. a system that obeys *superposition* (a) and *scaling* (b) is *linear*

Human response to an arbitrary stimulus

(Berns)

spectrum of stimulus arriving
in one small area on retina
 \times
spectral sensitivity of each
type of cone (L,M,S)
 $=$
multiply wavelength-by-
wavelength to get response spectra
 \int
integrate over wavelengths to get
total response for that type of cone \longrightarrow

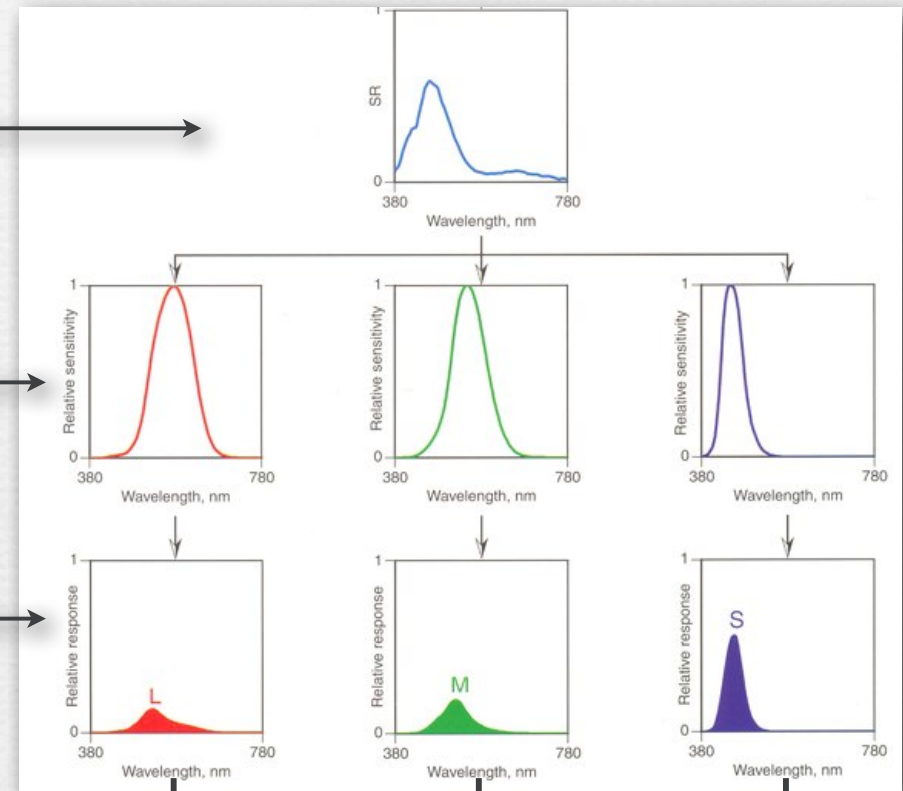

♦ output is three numbers (ρ , γ , β) per area on retina

Human response to an arbitrary stimulus

(Berns)

- ◆ stated another way, given a stimulus spectrum $L_e(\lambda)$, the human response to it (ρ, γ, β) are the integrals over all visible wavelengths of our responses

$$L_e(\lambda) \rho(\lambda),$$

$$L_e(\lambda) \gamma(\lambda),$$

$$L_e(\lambda) \beta(\lambda)$$

to each constituent wavelength λ , i.e.

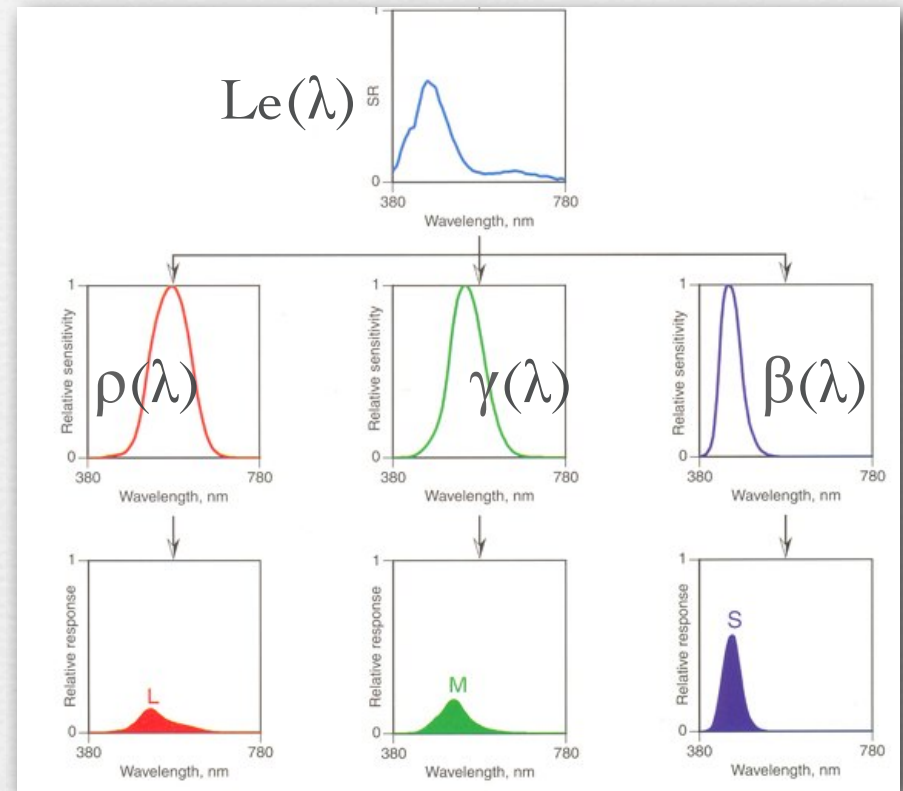

$$(\rho, \gamma, \beta) = \left(\int_{400 \text{ nm}}^{700 \text{ nm}} L_e(\lambda) \rho(\lambda) d\lambda, \int_{400 \text{ nm}}^{700 \text{ nm}} L_e(\lambda) \gamma(\lambda) d\lambda, \int_{400 \text{ nm}}^{700 \text{ nm}} L_e(\lambda) \beta(\lambda) d\lambda \right)$$

Questions?

Outline

- ◆ spectral power distributions
- ◆ color response in animals and humans
- 👉 ◆ 3D colorspace of the human visual system
 - and color filter arrays in cameras
- ◆ reproducing colors using three primaries
- ◆ additive versus subtractive color mixing
- ◆ cylindrical color systems used by artists (and Photoshop)
- ◆ chromaticity diagrams
 - color temperature and white balancing
 - standardized color spaces and gamut mapping

Human 3D colorspace

- ◆ the three types of cones in our retina (Long, Medium, Short wavelength) define the axes of a three-dimensional space
- ◆ our response to any stimulus spectrum can be summarized by three numbers (ρ , γ , β) and plotted as a point in this space
- ◆ our responses to all visible single-wavelength spectra (a.k.a. pure wavelengths λ , i.e. positions along the rainbow), if connected together, form a curve in this space, called the *locus of spectral colors*; the sequence of (ρ , γ , β) numbers form the *tristimulus sensitivity functions* $\rho(\lambda)$, $\gamma(\lambda)$, and $\beta(\lambda)$

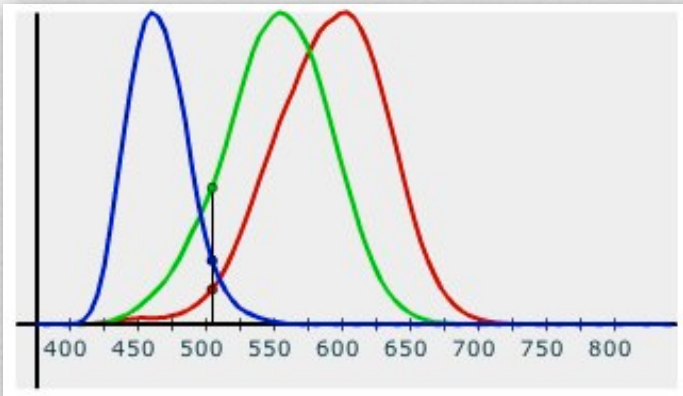

sensitivity functions

(FLASH DEMO)

<http://graphics.stanford.edu/courses/cs178/applets/locus.html>

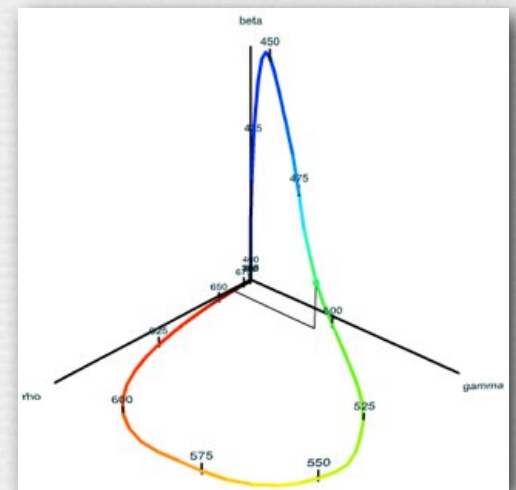

spectral locus

Properties of human 3D colorspace (1 of 2) (contents of whiteboard)

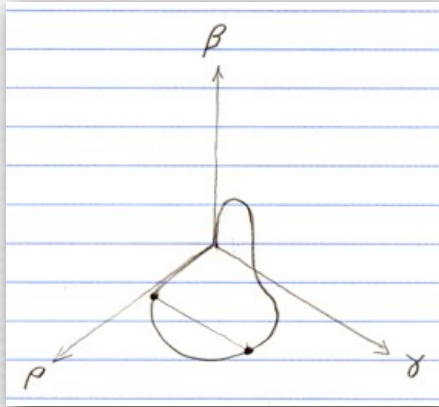

1

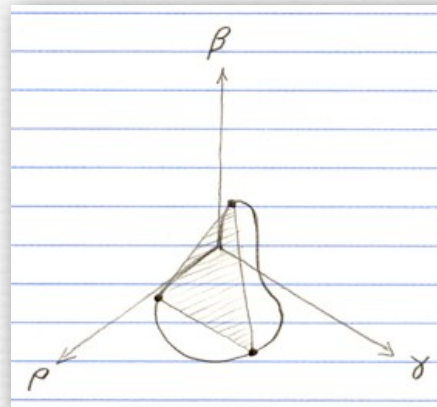

2

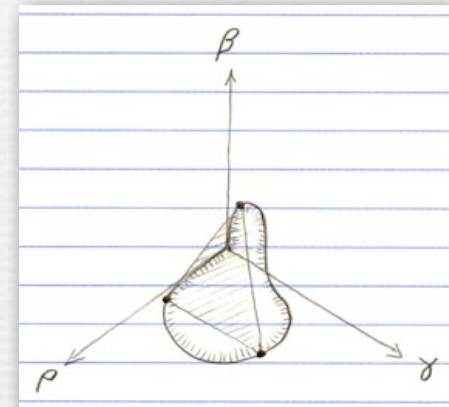

3

1. our response to any mixture ($\Sigma = 1$) of two pure wavelengths falls on a line connecting the responses to each wavelength
2. our response to any mixture ($\Sigma = 1$) of three pure wavelengths falls on a triangle connecting the responses to each wavelength; our response to any mixture ($\Sigma \leq 1$) of three pure wavelengths falls in a tetrahedron defined by this triangle and the origin
3. our responses to all possible mixtures ($\Sigma \leq 1$) of all visible wavelengths forms an irregular volume called the *gamut of perceivable colors*, equal to the convex hull of the spectral locus

Properties of human 3D colorspace (2 of 2) (contents of whiteboard)

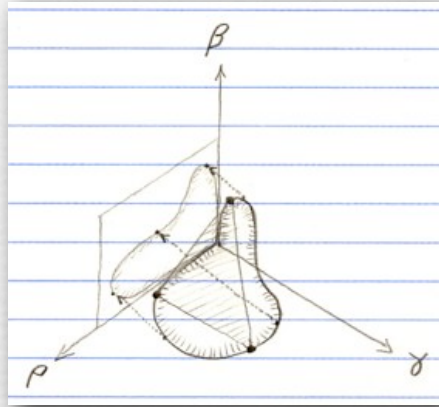

4

4. to a deuteranope - a color-blind person who is missing their medium-wavelength receptor, i.e. their gamma receptor - this diagram is squashed into the rectangle shown above on the rho-beta plane
- as a result, spectra whose (ρ, γ, β) responses lie along the dotted lines cannot be distinguished; they will appear as the same color, i.e. as metamers
 - by a similar argument, many spectra distinguishable to pentachromats (e.g. Mallard ducks) are indistinguishable to trichromats (humans)

Color blindness

37?

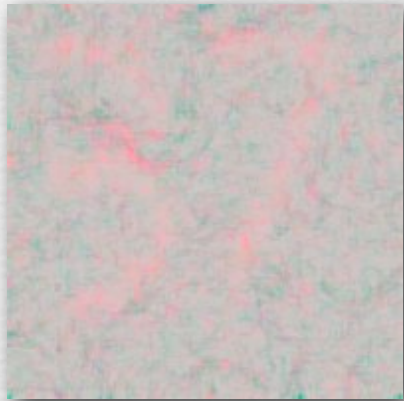

49?

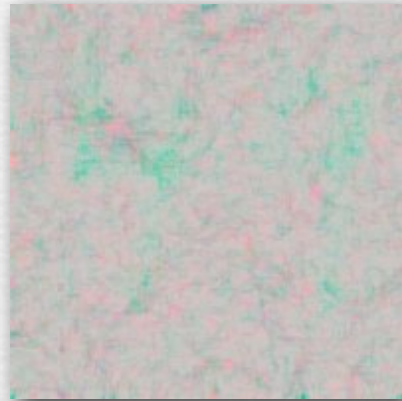

56?

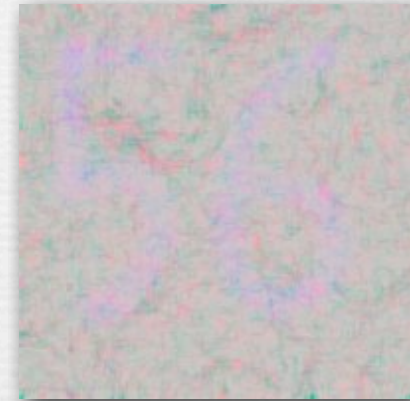

(wikipedia)

- ◆ protanopia (1% of males)
- ◆ deuteranopia (1% of males)
- ◆ tritanopia (< 1% of both genders)
- ◆ protanomaly (1% of males)
- ◆ deuteranomaly (6% of males)
- ◆ tritanomaly (< 1% of both genders)

The advantage of being color blind

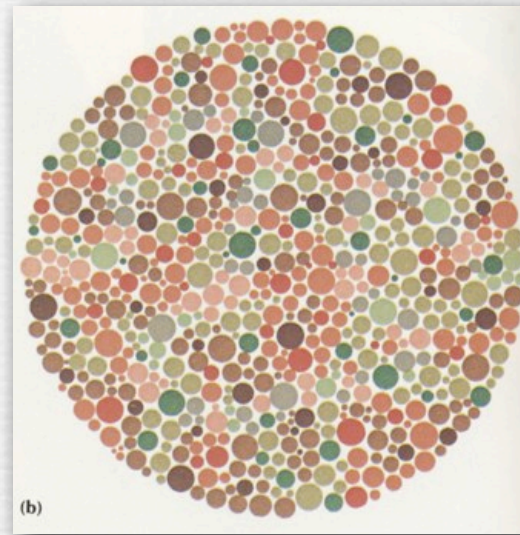
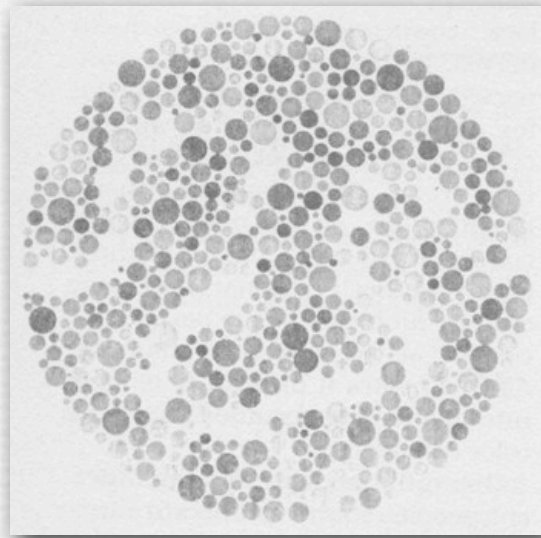

- ◆ the maze (at left) is recreated (at right) using subtle intensity differences, but overridden by stronger red-green color differences
- ◆ only a deuteranope can see the maze at right

Canon 30D color filters

- ♦ you want the camera's R, G, and B color filters to have the same spectral sensitivities as our L, M, and S cones
 - you don't want objects in the real world to be metamers to one system and not the other
 - otherwise, colored patterns the camera sees might be invisible to a person (bad), or patterns you see might be invisible to a camera (also bad)

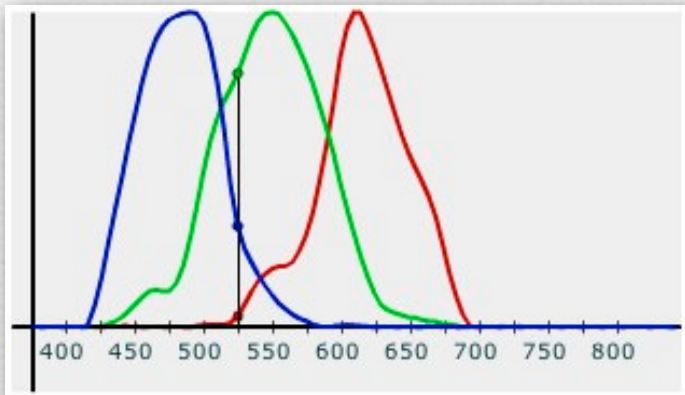

filter transmissivity

(FLASH DEMO)

<http://graphics.stanford.edu/courses/cs178/applets/locus.html>

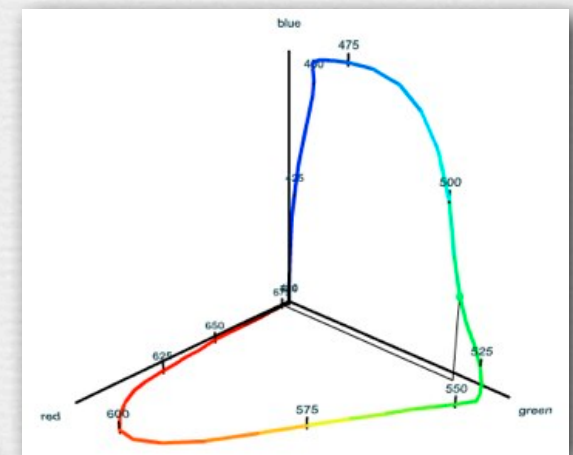

spectral locus

Questions?

Outline

- ◆ spectral power distributions
- ◆ color response in animals and humans
- ◆ 3D colorspace of the human visual system
 - and color filter arrays in cameras
-  ◆ reproducing colors using three primaries
- ◆ additive versus subtractive color mixing
- ◆ cylindrical color systems used by artists (and Photoshop)
- ◆ chromaticity diagrams
 - color temperature and white balancing
 - standardized color spaces and gamut mapping

Maxwell's color matching experiment

- ◆ Maxwell actually used a slightly different procedure
 - see <http://www.handprint.com/HP/WCL/color6.html> for details
 - the procedure below is used in modern versions of the experiment

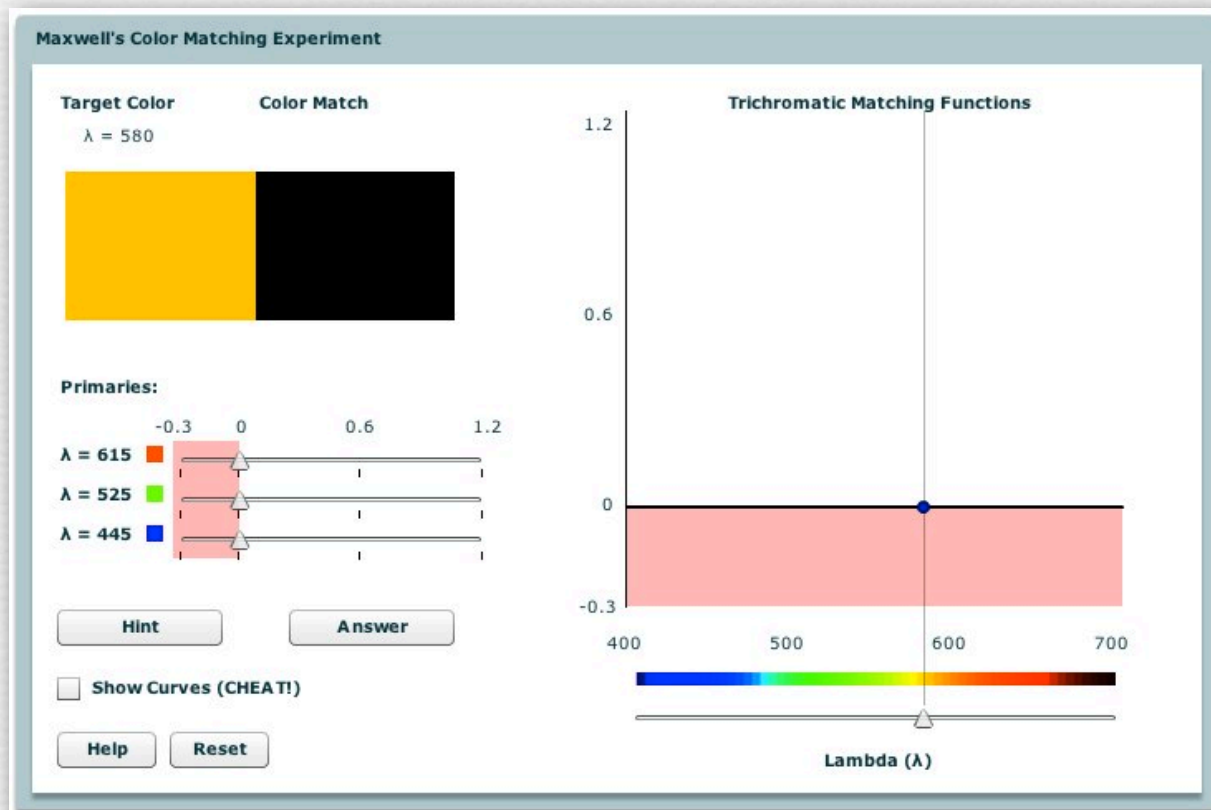

(FLASH DEMO)

<http://graphics.stanford.edu/courses/cs178/applets/colormatching.html>

Maxwell's color matching experiment

(summary of live demo)

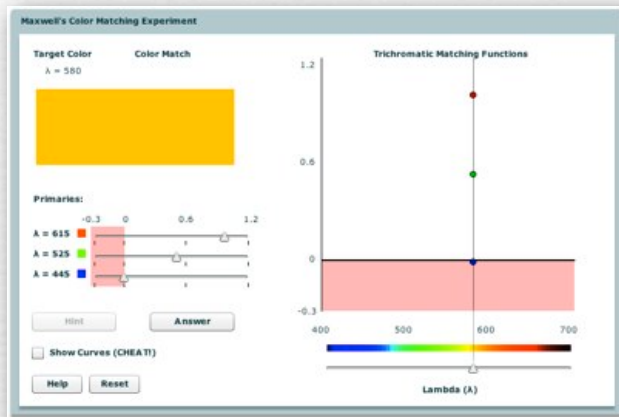

1

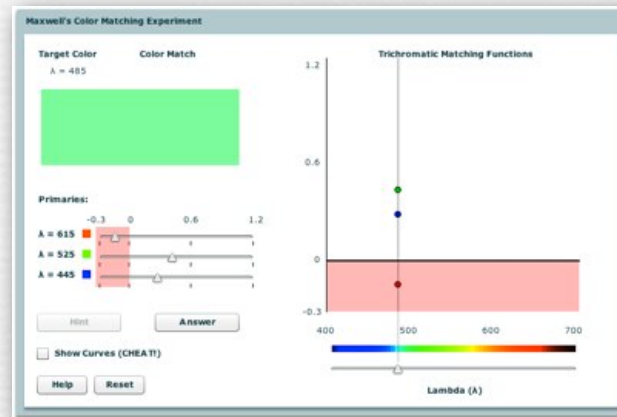

2

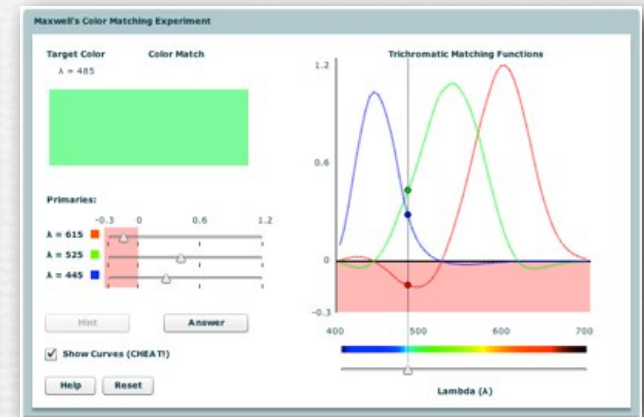

3

1. given a stimulus wavelength, the amount of each primary required to match it is given by three numbers (r, g, b)
2. some stimuli cannot be matched unless first desaturated by adding a primary to it before matching; the amount added is denoted by negative values of $r, g, \text{ or } b$
3. the sequence of $(\bar{r}, \bar{g}, \bar{b})$ values, some negative, required to match the locus of spectral colors across all λ , form the *trichromatic matching functions* $r(\lambda)$, $g(\lambda)$, and $b(\lambda)$ for a particular set of 3 primaries

Human response to an arbitrary stimulus (contents of whiteboard)

spectrum of stimulus

×

multiply wavelength-by-wavelength
by the matching functions
 $\bar{r}(\lambda)$, $\bar{g}(\lambda)$, and $\bar{b}(\lambda)$
for a particular set of 3 primaries

∫

then integrate over wavelengths to
get the amount of each primary
required to reproduce that spectrum

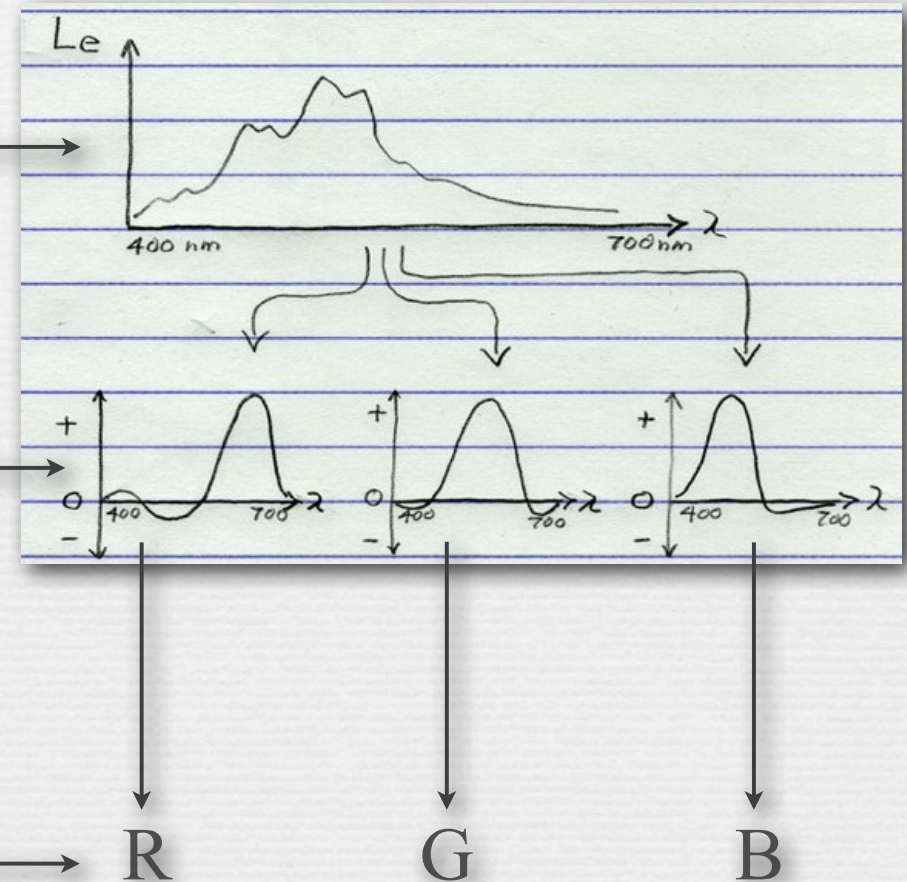

Young-Helmholtz trichromatic theory



Thomas Young
(1773-1829)



James Clerk Maxwell
(c. 1860)



Hermann von Helmholtz
(1821-1894)

- ◆ spectra can be visually matched using mixtures of *primary colors*; such matches are called *metamers*
- ◆ due to the linearity of human retinal response, given a stimulus spectrum $L_e(\lambda)$, the amounts of each primary R, G, B required to match it, for any particular choice of 3 primaries, are the integrals over all visible wavelengths of the amounts $r(\lambda)$, $g(\lambda)$, and $b(\lambda)$ required to match each constituent wavelength λ , *i.e.*

$$(R, G, B) = \left(\int_{400\text{nm}}^{700\text{nm}} L_e(\lambda) \bar{r}(\lambda) d\lambda, \int_{400\text{nm}}^{700\text{nm}} L_e(\lambda) \bar{g}(\lambda) d\lambda, \int_{400\text{nm}}^{700\text{nm}} L_e(\lambda) \bar{b}(\lambda) d\lambda \right)$$

3D interpretation of color matching

- ◆ our response to varying amounts of a primary forms a vector in (ρ, γ, β) space, rooted at the origin
- ◆ to provide a normal range of color vision, three primaries are required, and their vectors must not lie on a plane
- ◆ our responses to all possible mixtures ($\Sigma \leq 1$) of three primaries form a tetrahedron called the *gamut of reproducible colors* for these primaries

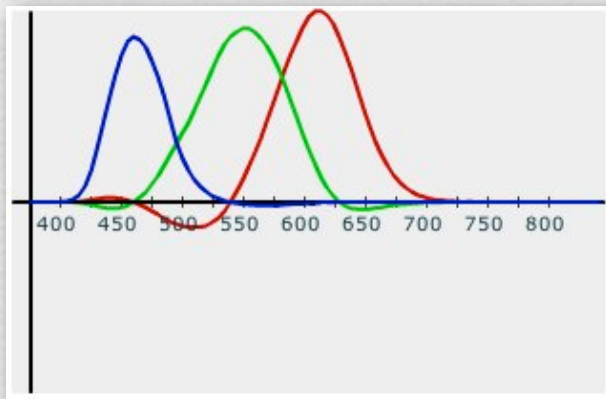

RGB matching functions

(FLASH DEMO)

<http://graphics.stanford.edu/courses/cs178/applets/locus.html>

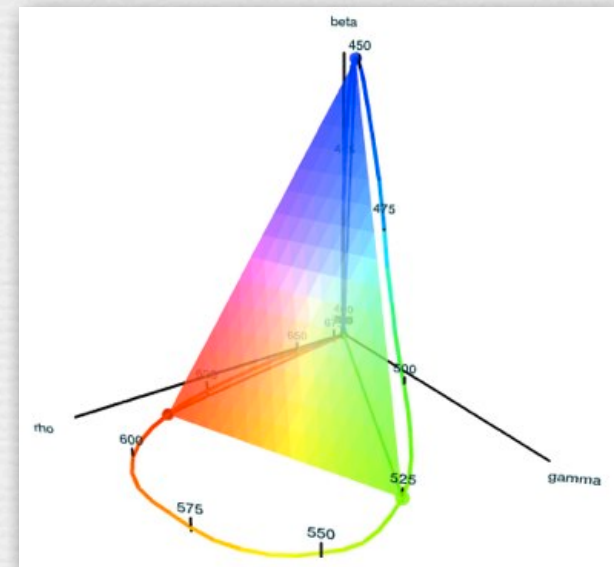

gamut of reproducible colors

3D interpretation of color matching

- ◆ the spectrum of each of the three primaries can be a pure wavelength (1) or a mixture of wavelengths (2)
- ◆ impure primaries have a smaller gamut in (ρ, γ, β) space
- ◆ additional primaries can be added to increase the gamut

1

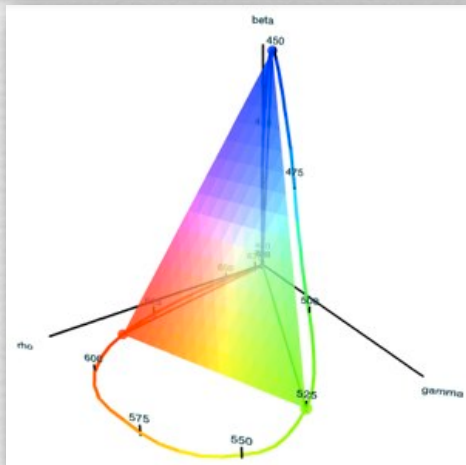
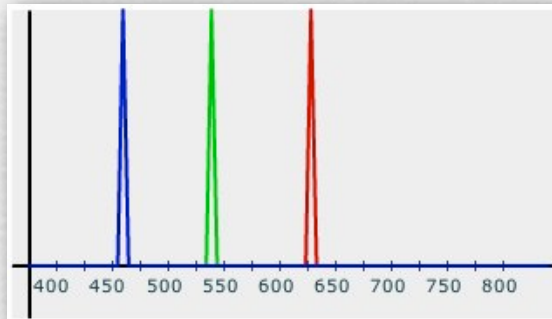

2

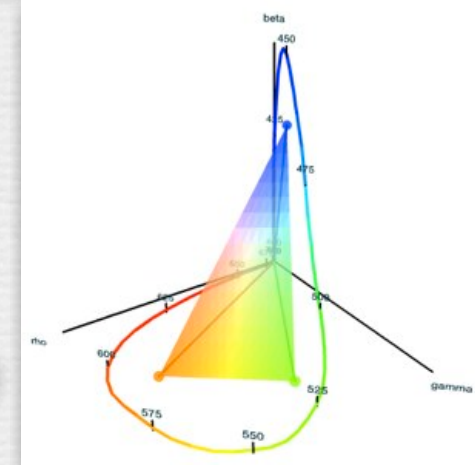
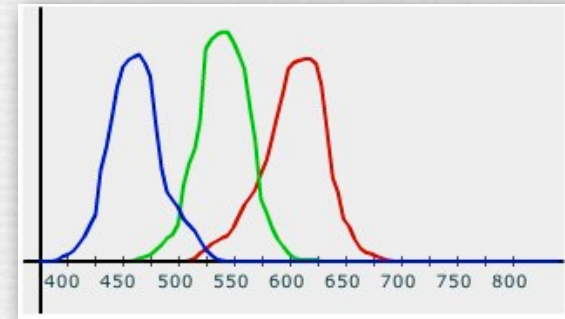

(FLASH DEMO)

<http://graphics.stanford.edu/courses/cs178/applets/locus.html>

Questions?

Outline

- ◆ spectral power distributions
- ◆ color response in animals and humans
- ◆ 3D colorspace of the human visual system
 - and color filter arrays in cameras
- ◆ reproducing colors using three primaries
-  ◆ additive versus subtractive color mixing
- ◆ cylindrical color systems used by artists (and Photoshop)
- ◆ chromaticity diagrams
 - color temperature and white balancing
 - standardized color spaces and gamut mapping

Additive versus subtractive mixing

- ◆ demo using color guns and filters

Additive versus subtractive mixing

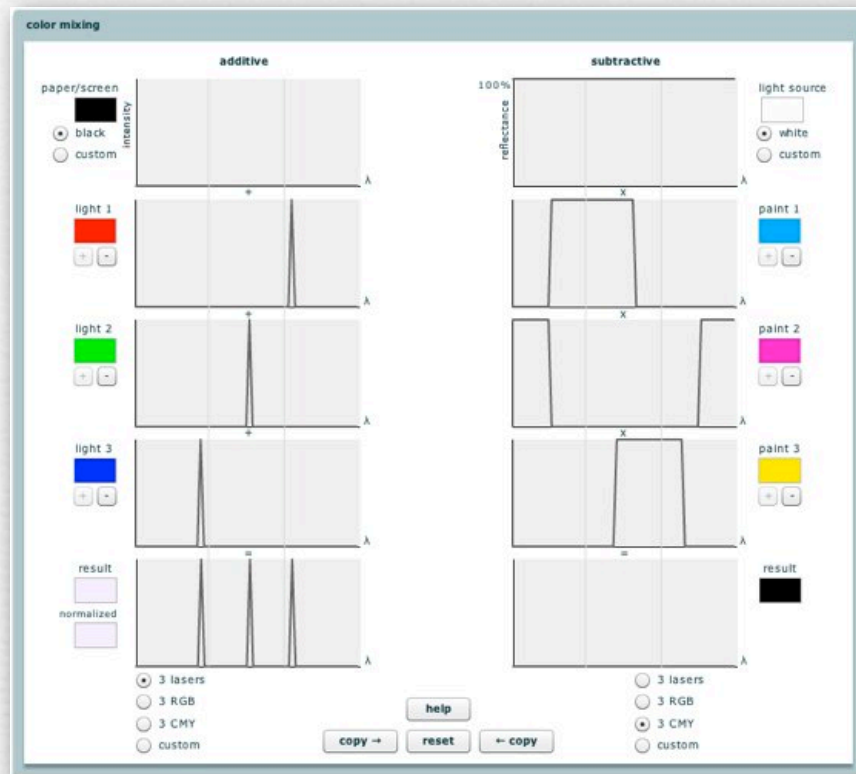

(FLASH DEMO)

<http://graphics.stanford.edu/courses/cs178/applets/ColorMixing-narrowCMY.swf>

- ◆ superimposed colored lights or small adjacent dots combine *additively* - by adding their spectra wavelength-by-wavelength
- ◆ layered dyes or sequenced color filters combine *subtractively* - by multiplying their transmittance spectra wavelength-by-wavelength

Additive versus subtractive mixing



(FLASH DEMO)

<http://graphics.stanford.edu/courses/cs178/applets/colormixing.html>

- ◆ superimposed colored lights or small adjacent dots combine *additively* - by adding their spectra wavelength-by-wavelength
- ◆ layered dyes or sequenced color filters combine *subtractively* - by multiplying their transmittance spectra wavelength-by-wavelength

Additive versus subtractive mixing

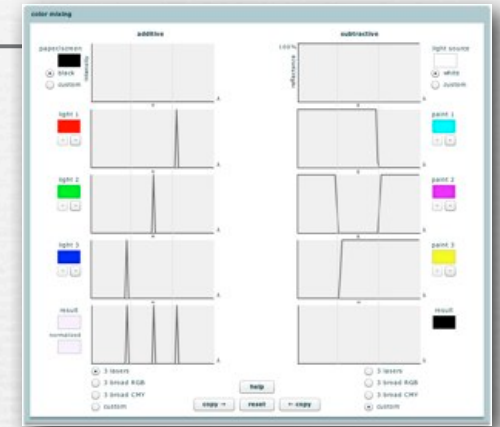

- ◆ narrow spectra, widely spaced in wavelength, are best for primaries to be combined additively
- ◆ wide spectra that overlap are best for primaries to be combined subtractively, but product of all three must be black
- ◆ the particular spectra chosen are flexible; additive primaries need not be R,G,B, nor subtractive primaries C,M,Y
- ◆ additional primaries may be added to either system, resulting in a larger gamut of reproducible colors; adding black to a subtractive system (called CMYK) ensures a deep black
- ◆ note: additive mixing can be interpreted as interpolation between points in rho-gamma-beta space, but subtractive mixing cannot, because the two spectra must be multiplied together, not added

Color printing

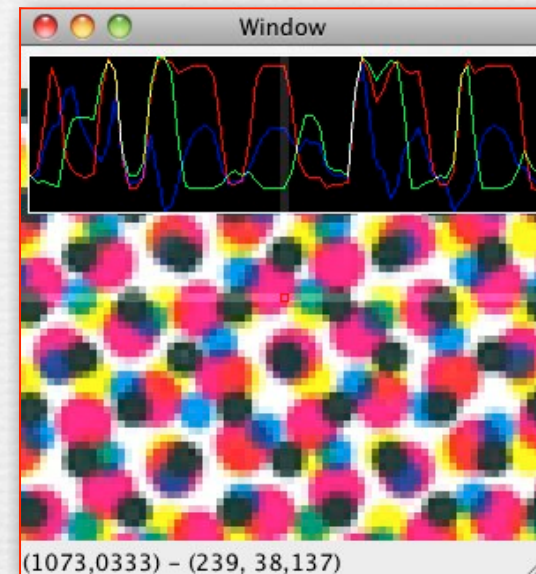
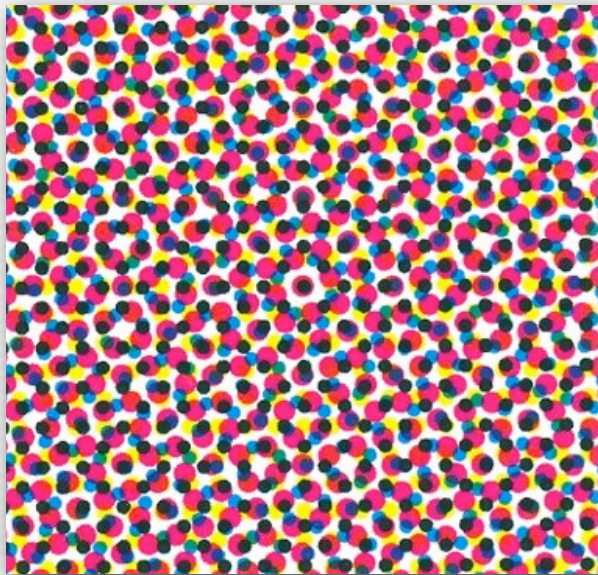

- ◆ patches of the 3 subtractive primaries (C,M,Y) overlap partially on the page, making patches of 8 meta-primaries (Wh,C,M,Y,CM,CY,MY,CMY), which combine additively in the eye when viewed from a distance
 - these effects are modeled by the *Neugebauer equations*